



Dobradiça injetada em zamak com pino em aço inox 304.
Elementos de fixação zincado branco ou preto.
Acabamento pintado em epóxi preto.

Dobradiça com Abertura 180°

Código Dimensões Fixação

40100 40 x 40 mm M5

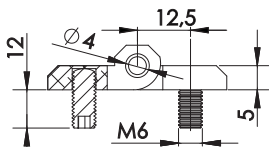
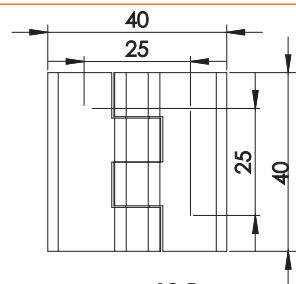

Código Dimensões Fixação

40200 50 x 50 mm M6

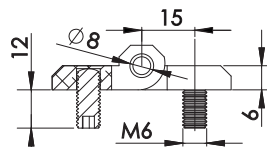
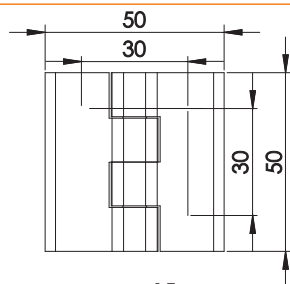

Código Dimensões Fixação

40500 60 x 60 mm M8

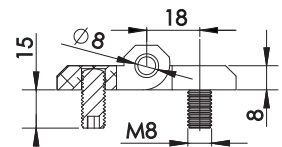
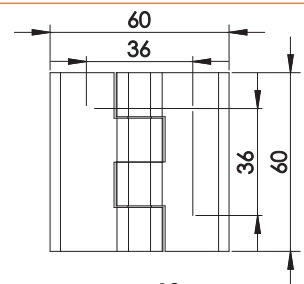

Dobradiça com Abertura 270°

Código Dimensões Fixação

40300 50 x 63 mm M6

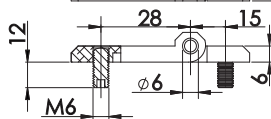
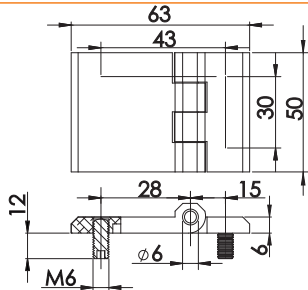

Código Dimensões Fixação

40600 60 x 90 mm M8

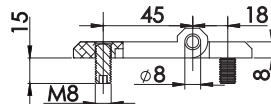
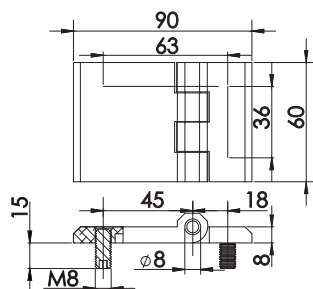

Código Dimensões Fixação

40400 50 x 76 mm M6

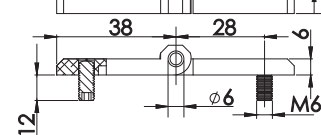
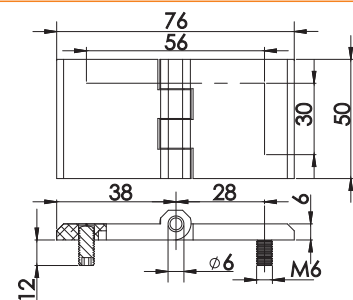

Código Dimensões Fixação

40700 60 x 120 mm M8

